



INTERNATIONAL APPLICATION PUBLISHED UNDER THE PATENT COOPERATION TREATY (PCT)

(51) International Patent Classification ⁷ : H04L 29/06, H04Q 7/24	A1	(11) International Publication Number: WO 00/28714
		(43) International Publication Date: 18 May 2000 (18.05.00)

<p>(21) International Application Number: PCT/SE99/01996</p> <p>(22) International Filing Date: 4 November 1999 (04.11.99)</p> <p>(30) Priority Data: 09/187.339 6 November 1998 (06.11.98) US</p> <p>(71) Applicant: TELEFONAKTIEBOLAGET LM ERICSSON (publ) [SE:SE]; S-126 25 Stockholm (SE).</p> <p>(72) Inventor: COMSTOCK, David; c/o Friström, Bollgatan 11, 4 tr, S-169 51 Solna (SE).</p> <p>(74) Agent: ERICSSON RADIO SYSTEMS AB; Common Patent Department, S-164 80 Stockholm (SE).</p>	<p>(81) Designated States: AE, AL, AM, AT, AU, AZ, BA, BB, BG, BR, BY, CA, CH, CN, CR, CU, CZ, DE, DK, DM, EE, ES, FI, GB, GD, GE, GH, GM, HR, HU, ID, IL, IN, IS, JP, KE, KG, KP, KR, KZ, LC, LK, LR, LS, LT, LU, LV, MA, MD, MG, MK, MN, MW, MX, NO, NZ, PL, PT, RO, RU, SD, SE, SG, SI, SK, SL, TJ, TM, TR, TT, TZ, UA, UG, UZ, VN, YU, ZA, ZW, ARIPO patent (GH, GM, KE, LS, MW, SD, SL, SZ, TZ, UG, ZW), Eurasian patent (AM, AZ, BY, KG, KZ, MD, RU, TJ, TM), European patent (AT, BE, CH, CY, DE, DK, ES, FI, FR, GB, GR, IE, IT, LU, MC, NL, PT, SE), OAPI patent (BF, BJ, CF, CG, CI, CM, GA, GN, GW, ML, MR, NE, SN, TD, TG).</p> <p>Published <i>With international search report.</i></p>
---	--

(54) Title: LAYER 2 TUNNELING FOR DATA COMMUNICATIONS IN WIRELESS NETWORKS

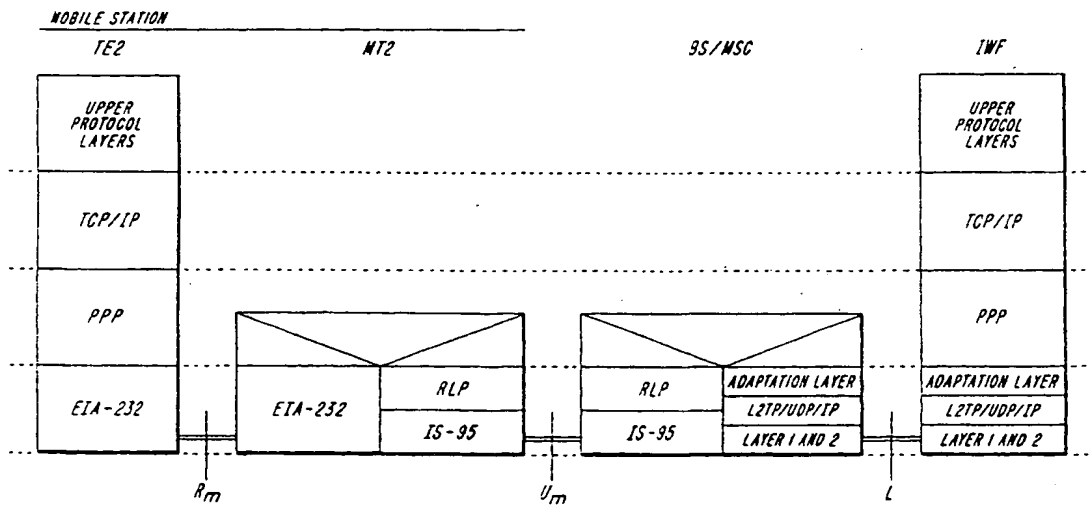

(57) Abstract

In accordance with an embodiment of the invention, IP networking and the Layer 2 Tunneling Protocol (L2TP) are used within a wireless data network to transport data between an IWF and a point where an RLP is terminated.

FOR THE PURPOSES OF INFORMATION ONLY

Codes used to identify States party to the PCT on the front pages of pamphlets publishing international applications under the PCT.

AL	Albania	ES	Spain	LS	Lesotho	SI	Slovenia
AM	Armenia	FI	Finland	LT	Lithuania	SK	Slovakia
AT	Austria	FR	France	LU	Luxembourg	SN	Senegal
AU	Australia	GA	Gabon	LV	Latvia	SZ	Swaziland
AZ	Azerbaijan	GB	United Kingdom	MC	Monaco	TD	Chad
BA	Bosnia and Herzegovina	GE	Georgia	MD	Republic of Moldova	TG	Togo
BB	Barbados	GH	Ghana	MG	Madagascar	TJ	Tajikistan
BE	Belgium	GN	Guinea	MK	The former Yugoslav Republic of Macedonia	TM	Turkmenistan
BF	Burkina Faso	GR	Greece	ML	Mali	TR	Turkey
BG	Bulgaria	HU	Hungary	MN	Mongolia	TT	Trinidad and Tobago
BJ	Benin	IE	Ireland	MR	Mauritania	UA	Ukraine
BR	Brazil	IL	Israel	MW	Malawi	UG	Uganda
BY	Belarus	IS	Iceland	MX	Mexico	US	United States of America
CA	Canada	IT	Italy	NE	Niger	UZ	Uzbekistan
CF	Central African Republic	JP	Japan	NL	Netherlands	VN	Viet Nam
CG	Congo	KE	Kenya	NO	Norway	YU	Yugoslavia
CH	Switzerland	KG	Kyrgyzstan	NZ	New Zealand	ZW	Zimbabwe
CI	Côte d'Ivoire	KP	Democratic People's Republic of Korea	PL	Poland		
CM	Cameroon	KR	Republic of Korea	PT	Portugal		
CN	China	KZ	Kazakstan	RO	Romania		
CU	Cuba	LC	Saint Lucia	RU	Russian Federation		
CZ	Czech Republic	LI	Liechtenstein	SD	Sudan		
DE	Germany	LK	Sri Lanka	SE	Sweden		
DK	Denmark	LR	Liberia	SG	Singapore		
EE	Estonia						

LAYER 2 TUNNELING FOR DATA COMMUNICATIONS IN WIRELESS NETWORKS

FIELD OF THE INVENTION

The present invention relates generally to data communications in wireless
5 networks.

BACKGROUND OF THE INVENTION

Modern wireless data networks typically include different kinds of data
links that are used to transport data between two elements in the network. For
example, when a mobile station (MS) within the data network sends a signal to an
10 end destination in the data network, the signal can travel from the MS over an air
interface wireless link to a base station (BS) or a mobile switching center (MSC).
The BS can be, for example, a base transceiver station (BTS), and a base station
controller (BSC). In third generation wireless data networks, the BS can also be
referred to as an RNC. After arriving at the BS or MSC, the signal can then be
15 relayed over a non-wireless link such as a landline, a public switched telephone
network (PSTN) with a modem at each end, an internet protocol (IP) network,
etc., and onward through the data network via the same or different links to the
end destination.

In particular, FIG. 1 shows a partial Network Reference Model for a TIA
20 TR45 network (TSB 100). This model is described in the reference TIA/EIA/TSB-
100, TR45 Wireless Network Reference Model, which is hereby incorporated by
reference. The interworking function (IWF) 102 supports data communications in
wireless data networks by "interworking" between a) protocols used to carry data
over wireless air interface links, as for example between an MS and a BS or an

-2-

MSC, and b) protocols used to carry the data onward through the data network via, for example, landlines. An IWF can be located, for example, at a BS or an MSC. When the signal transmitted over the wireless air interface from the MS to the BS is received at the MS, it will then be transported to the MSC or the IWF for further transport into the wireless data network, depending on the location of the IWF. A Y reference point 148 is defined in the IS-634 and IS-658 telecommunication standards (which are hereby incorporated by reference) as an interface between a wireless network entity (WNE) 134 and an IWF 102. The WNE is 134 is usually an MSC or a BS.

10 IS-634 defines an A interface between an MSC and a BS, and between two BSs. IS-634 also includes a specification for data transport between a BS and an IWF, and between an MSC and an IWF on the BS side of a network when the IWF is in the MSC.

IS-658 defines an L interface between the MSC or BS and the IWF, and is included in the Y reference point. The IS-658 standard has been defined by TR45.5, the IS-95 air interface standardization working group within TIA.

The IWF 102 shown in FIG. 1 is connected to a packet network PPDN 150 by a Pi interface 104.

20 Currently in code division multiple access (CDMA) wireless data network systems, for example systems consistent with the IS-95 telecommunications standard (which is hereby incorporated by reference) and the model shown in FIG. 1, a radio link protocol (RLP) for a wireless link between a BS and an MS in the system, can be terminated in the BS. Transport of data from the BS to other portions of the wireless data network system depends on the configuration of the system.

25 FIG. 2 shows, for example, a configuration where an IWF 202 is connected to a BS by an L interface 266 and a PSTN path 268. The L interface is an open interface between the IWF 202 and the BS 260, and Framereelay is

specified for data transport across the L interface 266 in IS-658. Switched virtual circuits (SVCs), which are specified in the telecommunications standard T1.617 (which is hereby incorporated by reference), are established when an air interface channel is established for transfer of packet data, for example between an MS and the BS 260 through the IWF 202. FIG. 2 also shows A interfaces A1 262 and A2 264 between the MSC 246 and the BS 260, which are specified in accordance with the IS-634 telecommunications standard.

The L interface 266 also has the characteristic that where a first user having an MS communicates with a second user having an MS or with any other kind of device (e.g., a non-mobile device) over the wireless data network system through the L interface 266, user-to-user parameters can be added to T1.617 messages moving across the L interface 266 as necessary.

When data transport to and/or from an MS in the wireless data network system involves circuit switched data calls within the network, the IWF can include landline modems (such as V.34 modems) for transporting the data to another landline modem. A "voice" circuit such as the IS-634 type interface A2 264 shown in FIG. 2 can be used to transport digitized modem signals between the IWF 202 and the MSC 246 via the BS 260. For packet data calls, the IWF 202 connects directly to an IP network (not shown) and does not use landline modems, thereby bypassing the MSC 246.

FIG. 3 shows a configuration different from the configuration shown in FIG. 2. In FIG. 3, the IWF 302 is connected to the MSC 346 instead of the BS 360, and the L interface 366 is located between the MSC 346 and the IWF 302. The RLP for a wireless link between an MS and the wireless data network system can be terminated in the BS 360, as in FIG. 2. An A5 interface 364 in accordance with the IS-634 standard is provided to transport data between the BS 360 and the MSC 346. The A5 interface 364 employs the Intersystem Link Protocol (ISLP) defined in the IS-728 standard (which is hereby incorporated by reference), which

-4-

uses flag stuffing to rate-adapt data flowing over the A5 interface 364 to bring it up to 64 kilobytes per second (64 kbps). The A5 interface 364 is limited to 64 kbps. In the configuration shown in FIG. 3, circuit switched modem signals are transported back to the MSC 346 for connection with a PSTN (not shown). As in
5 the configuration shown in FIG. 2, packet data is connected to an IP network (not shown) at the IWF 302 and would not need to be transported to the MSC 346. Since the L interfaces 266 and 366 shown in FIGS. 2 & 3 are based on Framereelay, one channel is not limited to a particular bandwidth.

FIG. 4 shows a protocol layer stack when an L interface based on IS-658 is used in a wireless data network system. Although FIG. 4 shows that the wireless
10 air interface U_m is configured according to the IS-95 CDMA standard, the wireless air interface U_m can be configured in accordance with other standards. For example, the wireless air interface U_m can have a time division multiple access (TDMA) configuration. For TDMA systems, the IWF is located in the MSC, and
15 the RLP is terminated in the IWF. The interface between the MS and the IWF is standardized at the data link layer, but the data transport is not specified. The A5 interface in accordance with IS-634 can be used if the transcoders are in the BS. The L interface can be used for the interface between a modem and the point where the RLP is terminated in the IWF. Alternatively, packet protocols can be
20 implemented.

The wireless data network systems described above have a limitation, in that the bandwidth between the BS and the MSC is limited to 64 kbps when the IWF is located between the MSC and an MS and the A5 interface is used, as shown for example in FIG. 3. This limitation will become increasingly restrictive
25 as future systems are implemented, particularly with respect to third generation systems. In addition, the L interface shown in FIGS. 2 & 3 specifies (and thereby requires) that transport across the L interface is Framereelay. This excludes other transport networks such as asynchronous transfer mode (ATM) networks, Ethernet

networks, etc. that may desirable for a variety of reasons, including increased versatility.

SUMMARY OF THE INVENTION

In accordance with an embodiment of the invention, IP networking and the
5 Layer 2 Tunneling Protocol (L2TP) are used to transport data in a wireless data
network between the IWF and a point where the RLP is terminated. Wireless data
networks in accordance with the invention confer several significant advantages.
First, the 64 kbps limitation of the A5 interface is removed. Second, the greater
flexibility of IP networking is provided. Third, wireless data networks in
10 accordance with embodiments of the invention do not require a specific transport
network, and can therefore use a variety of transport networks including
Framerelay, ATM PVCs, etc. Fourth, embodiments of the invention are
compatible with a general trend within the telecommunications industry of
networks migrating to IP.

15

BRIEF DESCRIPTION OF THE DRAWINGS

Other objects and advantages of the invention will become apparent to
those skilled in the art from the following detailed description of preferred
embodiments, when read in conjunction with the accompanying drawings. Like
elements in the drawings have been designated by like reference numerals.

20

FIG. 1 is diagram of a partial Network Reference Model for TIA TR45
networks.

FIG. 2 is a diagram showing a first configuration of an IWF, an MSC, and
a BS in a wireless data network.

25

FIG. 3 is a diagram showing a second configuration of an IWF, an MSC,
and a BS in a wireless data network.

-6-

FIG. 4 is a diagram showing a protocol layer stack in a wireless data network using either of the configurations shown in FIGS. 2 & 3.

FIG. 5 is a diagram showing a protocol layer stack in a wireless data network according to an embodiment of the invention.

5 FIG. 6 is a general block diagram of a wireless data network in accordance with various embodiments of the invention.

DETAILED DESCRIPTION OF THE INVENTION

In accordance with embodiments of the invention, IP networking and the Layer 2 Tunneling Protocol (L2TP) are used to transport data in a wireless data network between the IWF and a point where the RLP is terminated. L2TP is specified in the IETF (which is hereby incorporated by reference), and is both connection-oriented and transport independent. L2TP is also extensible, i.e., additional parameters can be added to support various functions required in specific implementations or applications of L2TP.

15 As shown in FIG. 6, in accordance with embodiments of the invention the L2TP can be used in a wireless data network between the BS 660 and the MSC 646, between the MSC 646 and the IWF 602, or between the IWF 602 and the BS 660.

20 Wireless data networks in accordance with the invention confer several significant advantages. First, the 64 kbps limitation of the A5 interface is removed. Second, the greater flexibility of IP networking is provided. Third, wireless data networks in accordance with embodiments of the invention do not require a specific transport network, and can therefore use a variety of transport networks including Framereley, ATM PVCs, etc. Fourth, embodiments of the invention are compatible with a general trend within the telecommunications industry of networks migrating to IP.

25

-7-

It will be appreciated by those skilled in the art that the present invention can be embodied in other specific forms without departing from the spirit or essential characteristics thereof, and that the invention is not limited to the specific embodiments described herein. The presently disclosed embodiments are therefore
5 considered in all respects to be illustrative and not restrictive. The scope of the invention is indicated by the appended claims rather than the foregoing description, and all changes that come within the meaning and range and equivalents thereof are intended to be embraced therein.

Claims:

1. A wireless data network, comprising:
an interworking function;
a mobile switching center;
5 a base station; and
at least one of
 - a) a Layer 2 Tunneling Protocol interface between the mobile
switching center and the base station;
 - b) a Layer 2 Tunneling Protocol interface between the base station
10 and the interworking function; and
 - c) a Layer 2 Tunneling Protocol interface between the mobile
switching center and the interworking function.

2. The wireless data network of claim 1, wherein each Layer 2 Tunneling
Protocol interface is an IP network for which data transport between the respective
15 mobile switching center, base station, and interworking function is specified to
follow a Layer 2 Tunneling Protocol.

3. The wireless data network of claim 1, wherein the network is a third
generation wireless data network.

4. The wireless data network of claim 1, wherein a Layer 2 Tunneling
20 Protocol is used to transport data between the interworking function and a point
within the network where a radio link protocol for a wireless link between the
base station and a mobile station is terminated.

5. A method for transporting data within a wireless network data system,
comprising at least one of the steps of:

transporting data over an IP network between a mobile switching center and a base station within the system in accordance with a Layer 2 Tunneling Protocol;

5 transporting data over an IP network between the mobile switching center and an interworking function within the system in accordance with the Layer 2 Tunneling Protocol; and

transporting data over an IP network between the base station and the interworking function within the system in accordance with the Layer 2 Tunneling Protocol.

10 6. The method of claim 5, wherein the wireless network data system is a third generation wireless network data system.

7. A method for transporting data within a wireless network data system comprising an interworking function and a base station, the method comprising the step of using a Layer 2 Tunneling Protocol to transport data between the
15 interworking function and a point within the network where a radio link protocol for a wireless link between the base station and a mobile station is terminated.

8. The method of claim 7, wherein the wireless network data system is a third generation wireless network data system.

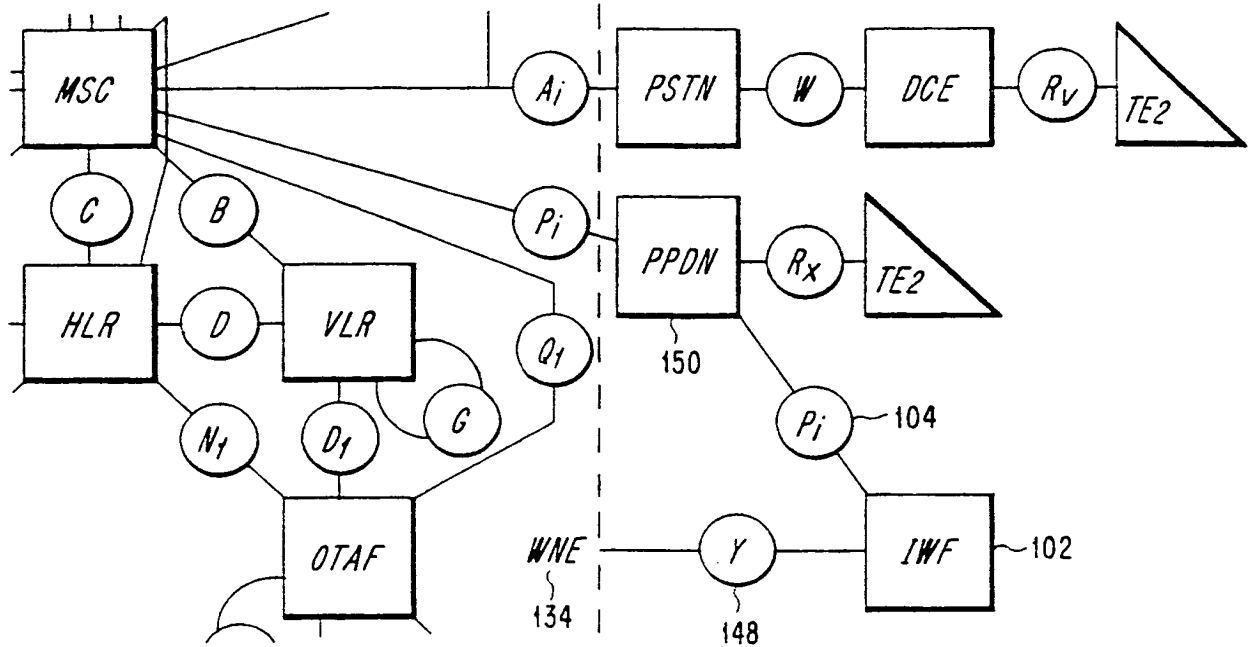

FIG. 1
PRIOR ART

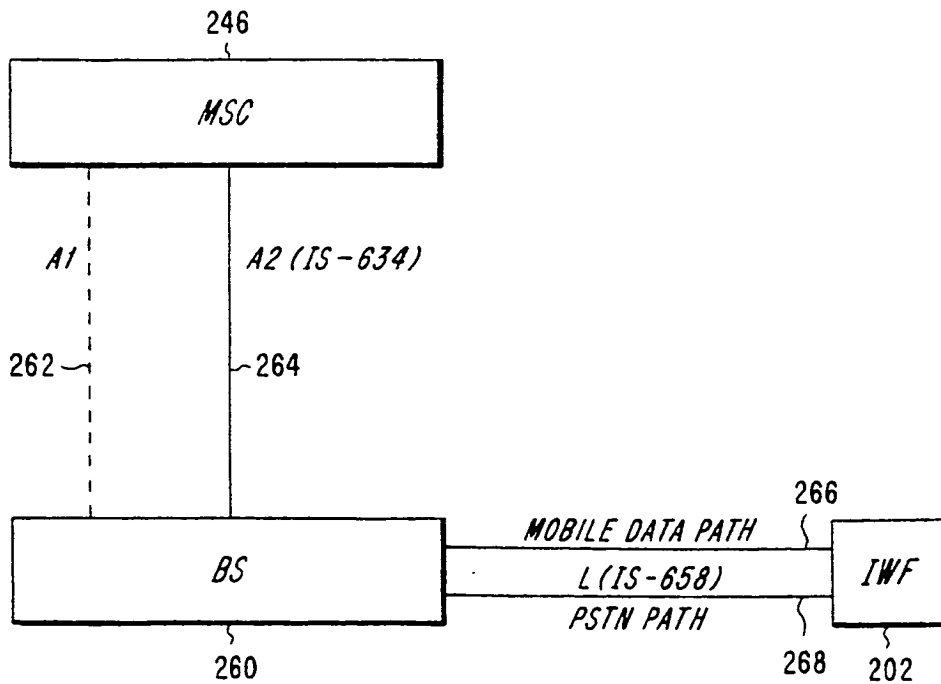

FIG. 2
PRIOR ART

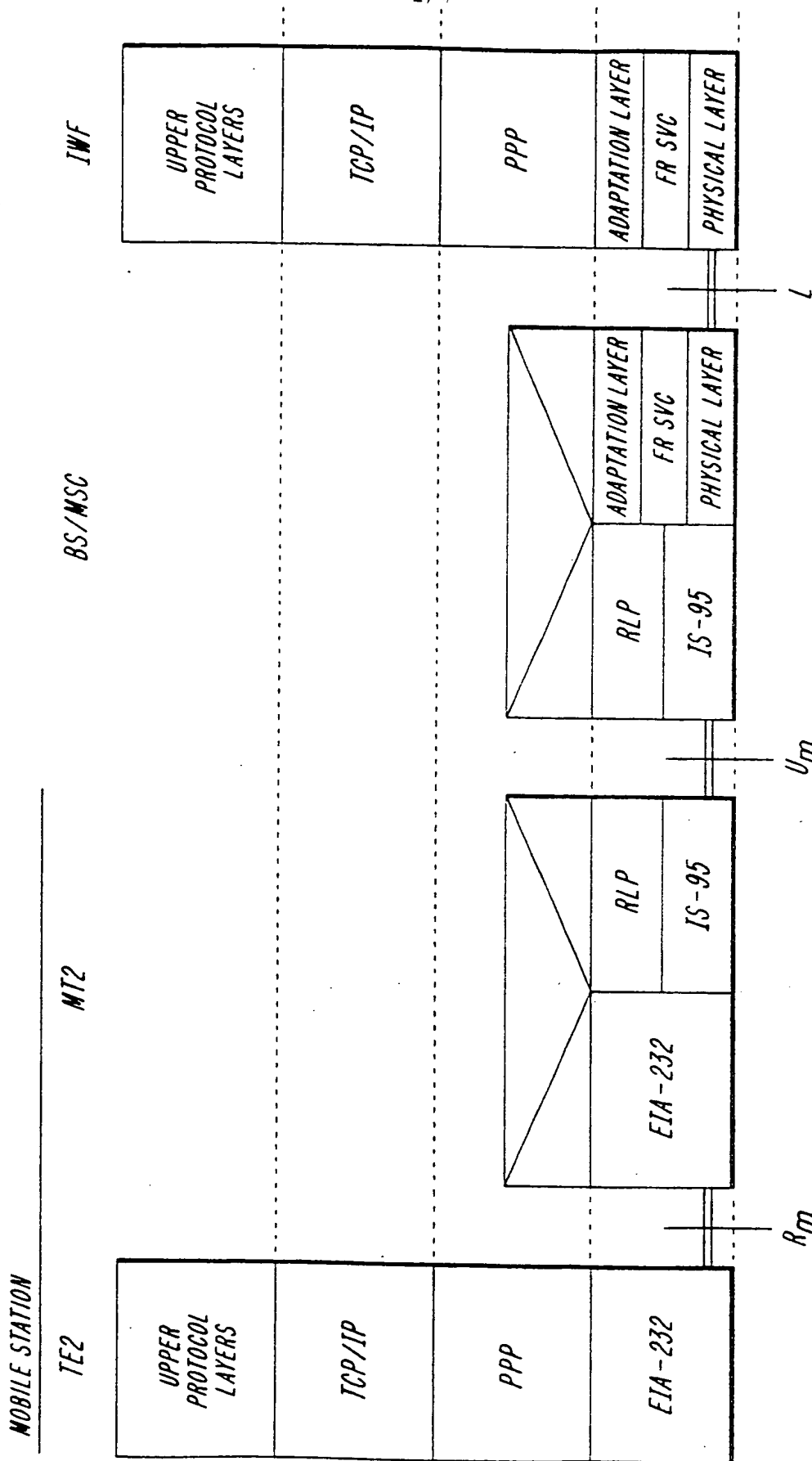

FIG. 4
PRIOR ART

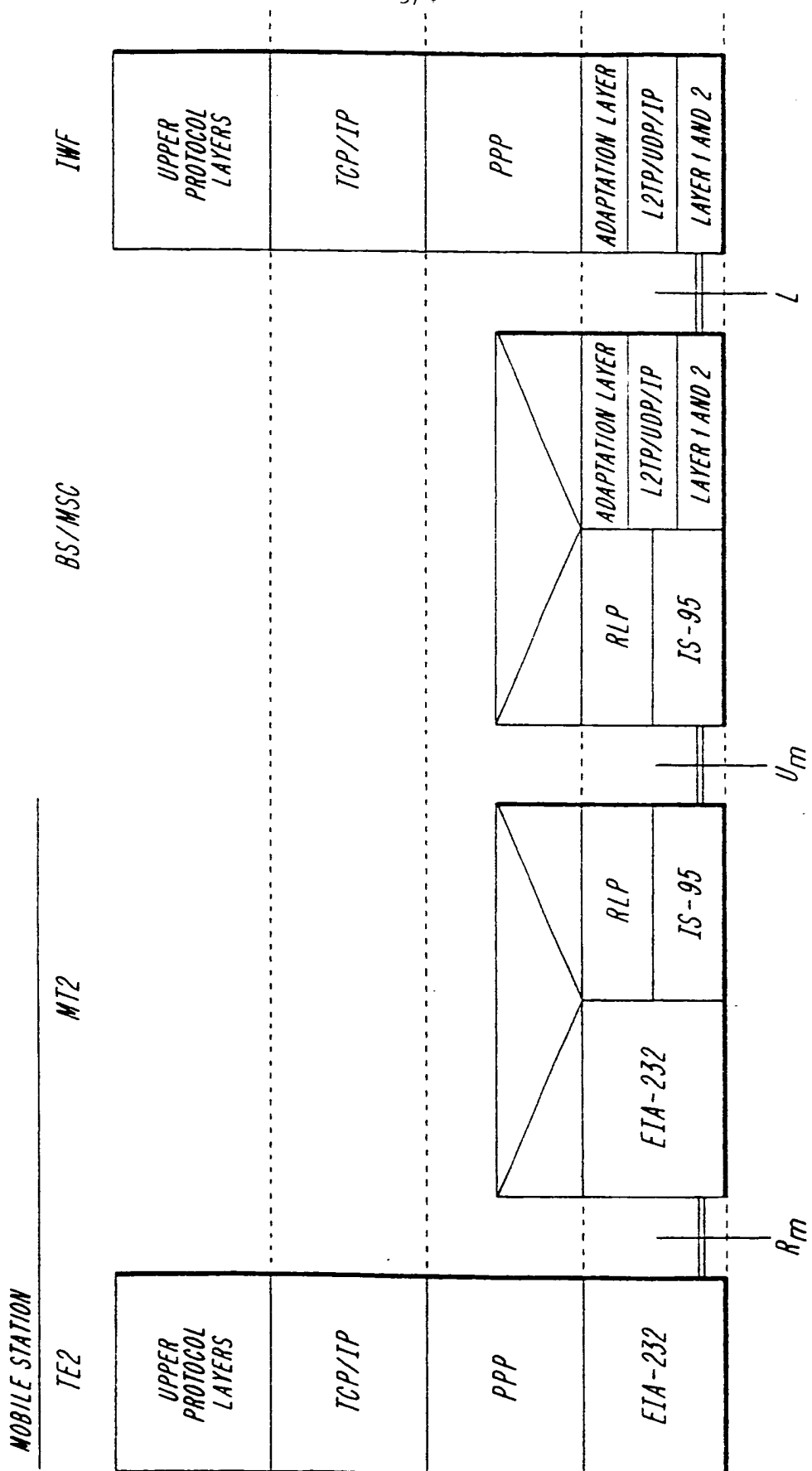

FIG. 5

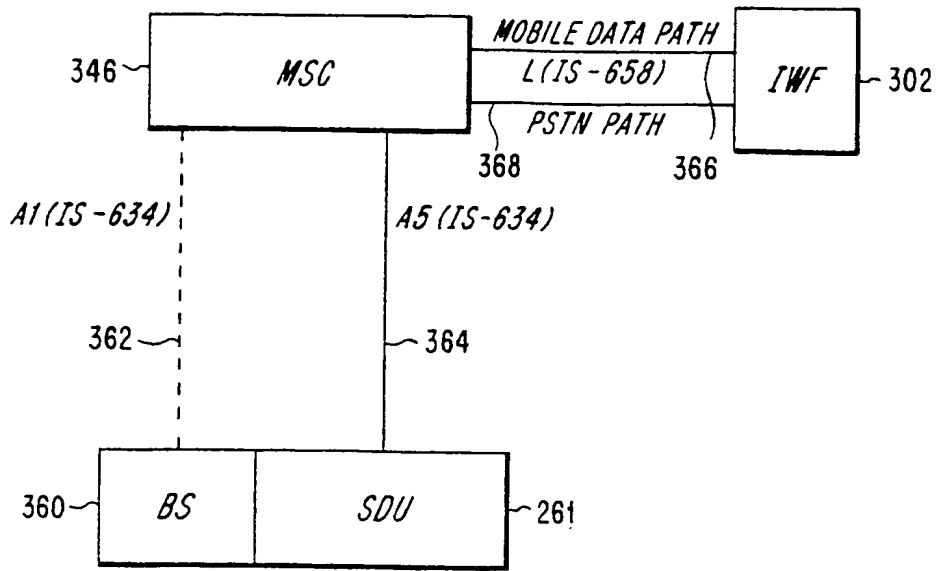

FIG. 3
PRIOR ART

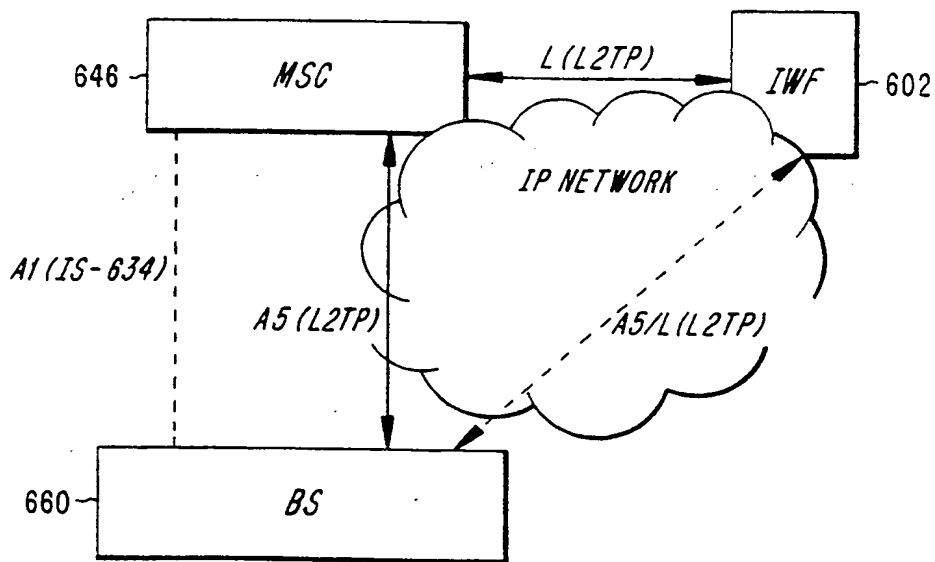

FIG. 6

INTERNATIONAL SEARCH REPORT

International Application No

PCT/SE 99/01996

A. CLASSIFICATION OF SUBJECT MATTER
 IPC 7 H04L29/06 H04Q7/24

According to International Patent Classification (IPC) or to both national classification and IPC

B. FIELDS SEARCHED

Minimum documentation searched (classification system followed by classification symbols)
 IPC 7 H04L H04Q

Documentation searched other than minimum documentation to the extent that such documents are included in the fields searched

Electronic data base consulted during the international search (name of data base and, where practical, search terms used)

C. DOCUMENTS CONSIDERED TO BE RELEVANT

Category *	Citation of document, with indication, where appropriate, of the relevant passages	Relevant to claim No.
Y	WO 96 21984 A (NOKIA TELECOMMUNICATIONS OY ;KARI HANNU H (FI); KARPPANEN ARTO (FI) 18 July 1996 (1996-07-18) page 1, line 5 -page 2, line 32 page 4, line 5 -page 7, line 18 page 8, line 18 -page 9, line 32 page 10, line 27 -page 12, line 12 figure 1	1-8
Y	WO 98 17076 A (ERICSSON TELEFON AB L M) 23 April 1998 (1998-04-23) abstract page 1, line 6 -page 3, line 28 page 4, line 26 -page 6, line 25 page 7, line 7 -page 14, line 2 figures 1,3,5	1-8

Further documents are listed in the continuation of box C.

Patent family members are listed in annex.

* Special categories of cited documents :

- "A" document defining the general state of the art which is not considered to be of particular relevance
- "E" earlier document but published on or after the international filing date
- "L" document which may throw doubts on priority claim(s) or which is cited to establish the publication date of another citation or other special reason (as specified)
- "O" document referring to an oral disclosure, use, exhibition or other means
- "P" document published prior to the international filing date but later than the priority date claimed

- "T" later document published after the international filing date or priority date and not in conflict with the application but cited to understand the principle or theory underlying the invention
- "X" document of particular relevance; the claimed invention cannot be considered novel or cannot be considered to involve an inventive step when the document is taken alone
- "Y" document of particular relevance; the claimed invention cannot be considered to involve an inventive step when the document is combined with one or more other such documents, such combination being obvious to a person skilled in the art.
- "&" document member of the same patent family

Date of the actual completion of the international search

17 February 2000

Date of mailing of the international search report

24/02/2000

Name and mailing address of the ISA
 European Patent Office, P.B. 5818 Patentlaan 2
 NL - 2280 HV Rijswijk
 Tel. (+31-70) 340-2040. Tx. 31 651 epo nl.
 Fax (+31-70) 340-3016

Authorized officer

Vaskimo, K

INTERNATIONAL SEARCH REPORT

International Application No

PCT/SE 99/01996

C. (Continuation) DOCUMENTS CONSIDERED TO BE RELEVANT

Category *	Citation of document, with indication, where appropriate, of the relevant passages	Relevant to claim No.
Y	PETER RYSAVY: "General Packet Radio Service (GPRS)" PCS DATA TODAY, 30 September 1998 (1998-09-30), pages 1-6, XP002094882 http://www.pcsdata.com/paprysavv.htm the whole document	1-8
Y	MALKIN GARY SCOTT: "DIAL-IN VIRTUAL PRIVATE NETWORKS USING LAYER 3 TUNNELING" PROCEEDINGS OF THE CONFERENCE ON LOCAL COMPUTER NETWORKS, 2 November 1997 (1997-11-02), pages 555-561, XP002084438 abstract page 555, paragraph 1.	1,2,4,5, 7
A	EP 0 766 490 A (NOKIA MOBILE PHONES LTD) 2 April 1997 (1997-04-02) page 2, line 3 - line 14 page 5, line 36 -page 6, line 8 page 9, line 7 - line 23	1-8
A	US 5 590 133 A (BILLSTROEM LARS ET AL) 31 December 1996 (1996-12-31) abstract column 3, line 53 -column 4, line 37 column 7, line 40 -column 8, line 46 column 18, line 8 - line 27 column 21, line 26 -column 24, line 27	1-8
A	WO 97 21313 A (NORTHERN TELECOM LTD ;RICHARDSON KENNETH (GB); SAYERS IAN (GB)) 12 June 1997 (1997-06-12) abstract	1-8
A	PAUL MALLINDER: "IP Virtual Dialup Networks" INTERNET DOCUMENT, March 1998 (1998-03), pages 1-6, XP002094883 http://itmag.com/articles/itmag/FirstQ/qleci.htm the whole document	1-8

INTERNATIONAL SEARCH REPORT

information on patent family members

International Application No

PCT/SE 99/01996

Patent document cited in search report		Publication date	Patent family member(s)	Publication date
WO 9621984	A	18-07-1996	FI 950117	A 11-07-1996
			AU 699246	B 26-11-1998
			AU 4392996	A 31-07-1996
			CA 2209944	A 18-07-1996
			EP 0804845	A 05-11-1997
			JP 10512120	T 17-11-1998
			NO 973176	A 09-09-1997
			US 5978386	A 02-11-1999
			WO 9817076	A
AU 4730797	A 11-05-1998			
BR 9712355	A 31-08-1999			
EP 0932990	A 04-08-1999			
ZA 9708834	A 21-09-1998			
EP 0766490	A	02-04-1997	FI 954639	A 30-03-1997
			JP 9130405	A 16-05-1997
			US 5956331	A 21-09-1999
US 5590133	A	31-12-1996	AU 675898	B 20-02-1997
			AU 1251595	A 27-06-1995
			CA 2153871	A 15-06-1995
			CN 1117335	A 21-02-1996
			EP 0683963	A 29-11-1995
			FI 953775	A 09-08-1995
			JP 8506713	T 16-07-1996
			WO 9516330	A 15-06-1995
			SG 43755	A 14-11-1997
WO 9721313	A	12-06-1997	GB 2307827	A 04-06-1997
			GB 2307828	A 04-06-1997